

# HIOKI

## MEMORY HILOGGER LR8450



**NEW**



## Wireless data logging at 1 kS/s (1 ms)

330-channel portable logger  
available with your choice of plug-in modules and wireless modules

**NEW**

- Voltage**  
1 kS/s (1 ms)
- Strain**  
1 kS/s (1 ms)
- Temperature**  
100 S/s (10 ms)
- Humidity**  
100 S/s (10 ms)
- Resistance**  
100 S/s (10 ms)
- CAN**  
100 S/s (10 ms)



Instruments with firmware version 2.00 and later support CAN measurement.  
(Measurement photographs for illustrative purposes only.)

# Two models: Standard Model and Wireless LAN Model



## Standard model (designed for use with plug-in modules only) LR8450

You can add up to 4 plug-in modules which provides 120 channels of measurement



Configuration example:  
120 channels of analog input

### Plug-in units

VOLTAGE/TEMP UNIT U8552 × 4

Each VOLTAGE/TEMP UNIT U8552 accepts 30 channels of input. Add four units for 120 channels of measurement.

Depending on various scenes, you can freely combine six types of plug-in modules

Measurement target  Analog input

<b>Voltage</b> kS/s (1 ms)	<b>Temperature</b> 100 S/s (10 ms)
<b>Strain</b> kS/s (1 ms)	<b>Humidity</b> 100 S/s (10 ms)
<b>Resistance</b> 100 S/s (10 ms)	<b>CAN</b> 100 S/s (10 ms)

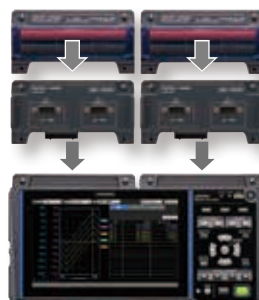

Configuration example:  
60 channels of analog input +  
1,000 channels of CAN input

### Plug-in units

VOLTAGE/TEMP UNIT U8552 × 2  
CAN UNIT U8555 × 2

Each VOLTAGE/TEMP UNIT U8552 accepts 30 channels of input. Each CAN UNIT U8555 accepts 500 channels of input.

## Wireless LAN model

Add channels freely via either plug-in or wireless modules

Can also be used exclusively with wireless modules



## Wireless LAN model LR8450-01

Add up to 7 wireless modules in total for a maximum of 330 channels

Configuration example: 330 channels

### Plug-in modules

VOLTAGE/TEMP UNIT U8552 × 4



+

### Wireless modules

WIRELESS VOLTAGE/TEMP UNIT LR8532 × 7



With four U8552 VOLTAGE/TEMP UNITS and seven LR8532 WIRELESS VOLTAGE/TEMP UNITS, you can measure a total of 330 channels.

## Mix plug-in and wireless modules

Mixing and matching plug-in modules and wireless modules will allow you to build a measurement system that suits your needs.\*1

If wireless modules are used with other modules (wireless or plug-in), the sampling-timing shift between the units is periodically corrected.\*2

In addition, at times when the wireless communication is cut off, the correction function works after the communication is restored and the sampling-timing shift between the modules is corrected.

\*1 Up to four CAN modules can be used at the same time. (Plug-in and wireless modules may be used in any combination.)

\*2 Even in good wireless communication conditions (low interference) the sampling-timing between modules may shift about 20 ms. In bad wireless conditions, the sampling-timing shift will be much worse than this.



# Voltage measurement



## Measure outputs from a pressure sensor and other sensors at 1 kS/s max. sampling rate (1 ms interval sampling)

1 kS/s sampling is necessary to record outputs of several tens of Hertz from pressure sensors and vibration sensors.



HIGH SPEED VOLTAGE UNIT U8553



WIRELESS HIGH SPEED VOLTAGE UNIT LR8533

# Temperature measurement

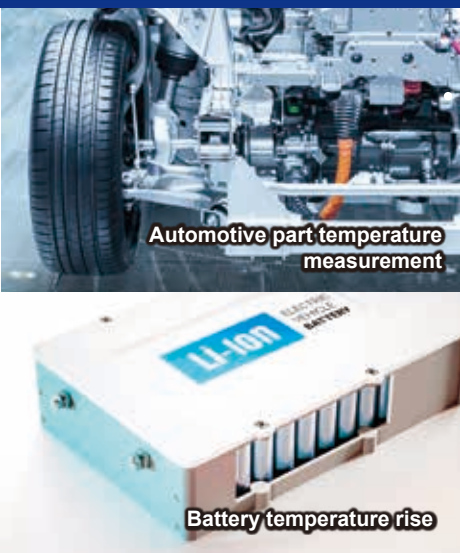

## Measure temperature near inverters and batteries at a sampling rate of up to 100 S/s (10 ms interval sampling)



VOLTAGE/TEMP UNIT U8550  
UNIVERSAL UNIT U8551  
VOLTAGE/TEMP UNIT U8552(\*)



WIRELESS VOLTAGE/TEMP UNIT LR8530  
WIRELESS UNIVERSAL UNIT LR8531  
WIRELESS VOLTAGE/TEMP UNIT LR8532(\*)

\*Sampling rate of 100 S/s (10 ms) is available when using 15 or fewer channels.

### Consistent sampling rate even with added modules

Each module incorporates its own A/D converter. This design keeps the maximum sampling rate high even when Modules are added.

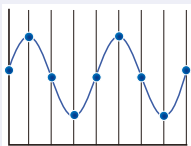

Example 1: use four U8553 HIGH SPEED VOLTAGE UNITS (with 5 channels each) to measure 20 channels at a sampling rate of 1 kS/s (1 ms).

Example 2: Use four U8550 VOLTAGE/TEMP UNITS (with 15 channels each) to sample 60 channels at a sampling rate of 100 S/s (10 ms).

### Consistent noise resistance even with added modules

Since increasing the number of modules has no effect on the cutoff frequency, which changes with the sampling rate, power supply noise can be reduced without sacrificing noise resistance.

(ex.) Sampling rate: 1 S/s

Number of channels	Cutoff frequency
1 ch to 15 ch	60 Hz
16 ch to 30 ch	60 Hz
31 ch to 45 ch	60 Hz
46 ch to 60 ch	60 Hz

\*When using a power supply frequency of 60 Hz.

↑  
Same cutoff frequency

### Set filters

#### Set filters for each module

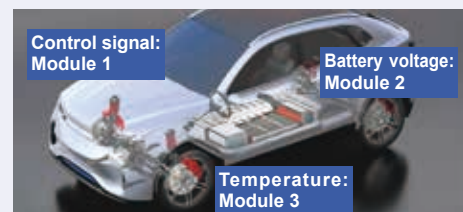

The cutoff frequency, which varies with the data refresh interval, can be set separately for each module. You can use long data refresh intervals, which boost filter effectiveness, and short data refresh intervals for different modules at the same time.

- Measure control signals at maximum speed: module 1 (data refresh interval: 1 ms)
- Measure battery voltage fluctuations: module 2 (data refresh interval: 1 ms)
- Measure temperature using thermocouples: module 3 (data refresh interval: 1 s) with **strong filter**

# Strain measurement

## Measure strain with a 1 kS/s sampling rate (1 ms)

Connect strain gages directly and measure at a sampling rate of up to 1 kS/s. Strain gages tend to have long, thin wires that are easily broken, but that potential pitfall can be avoided by using wireless modules so that wiring is minimized.



STRAIN UNIT U8554



WIRELESS STRAIN UNIT LR8534



Stress and load on moving parts

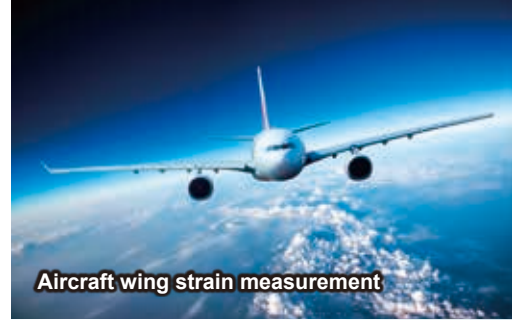

Aircraft wing strain measurement

## Connect strain gages directly

The strain units have a built-in bridge box, allowing you to connect strain gages directly to their input terminals.

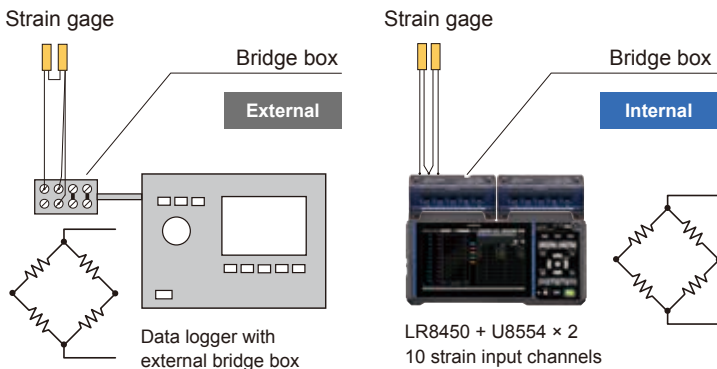

Strain-gage-type converters such as load sensors and pressure sensors can be connected directly to make measurement.



Brake and pipe strain measurement



Pipe strain measurement

### Reduced influence of noise

## Stable measurement, even at high voltages and high frequencies

Most competing loggers are incapable of measuring temperature accurately in noisy environments due to the influence of high frequencies, causing values to shift or fluctuate significantly. The LR8450 uses a new design to dramatically reduce the influence of high-frequency noise.

Example: measure temperature by connecting the tip of a K thermocouple to the screw on an inverter's PWM output terminal (W-phase) when using the U8550 VOLTAGE/TEMP UNIT (settings: 10 S/s sampling in the 100°C f.s. range).

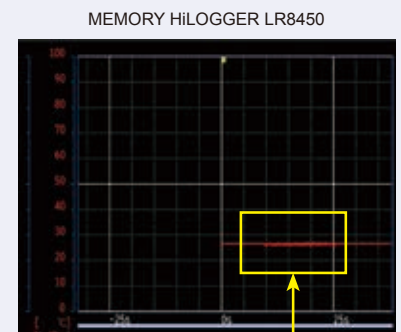
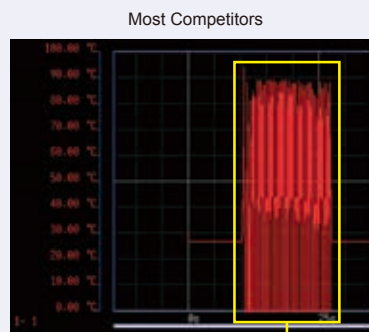
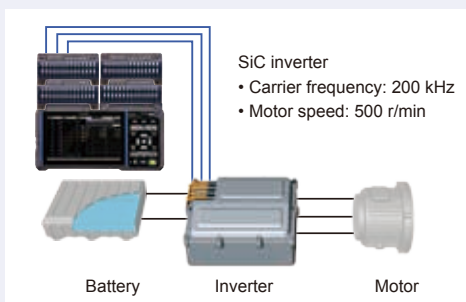

Most competing loggers exhibit significant fluctuations when the inverter is operating, whereas the MEMORY HILOGGER LR8450 does not.

# CAN measurement NEW



## One instrument, two uses: CAN input + CAN output of measured values

	U8555	LR8535
Input: CAN and CAN FD	Yes	Yes
Output: CAN and CAN FD	Yes	No

## CAN input

U8555      LR8535

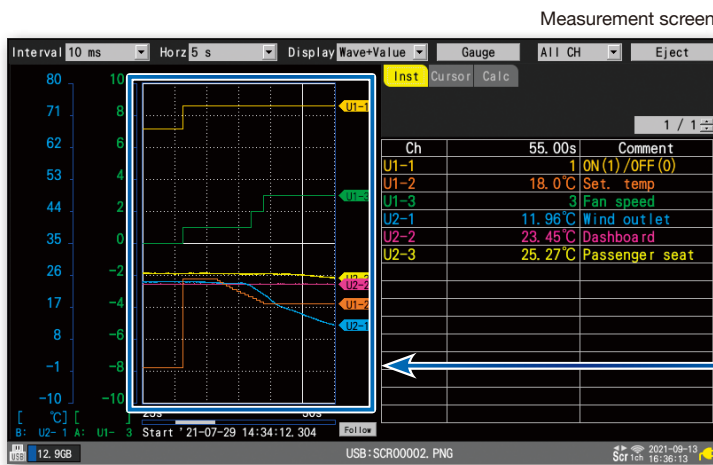
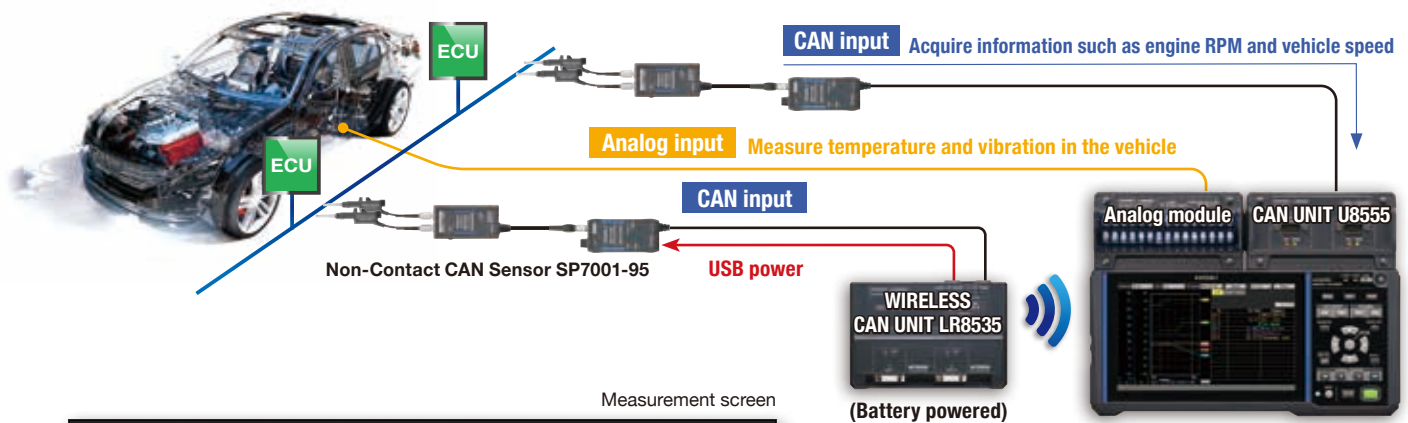

## Graph CAN signal information and analog data simultaneously

Captured CAN data → Measured analog data → Display of waveforms on same time axis

CAN signals are converted into analog waveforms and graphed in real time. (CAN signal waveforms themselves cannot be observed.) Simultaneously review waveforms for analog data such as voltage, temperature, and strain along with information acquired from the CAN bus such as vehicle speed and engine RPM.

## Receive CAN signals using a contactless, wireless setup!

Wireless modules interoperate flawlessly with the NON-CONTACT CAN SENSOR SP7001-95! Supply power from the battery-driven wireless unit to the NON-CONTACT CAN SENSOR SP7001-95 via USB to implement a wireless CAN measurement setup that requires no external power supply. (The system can operate for about five hours on battery power.) Since no ECU analysis tools or computer is required, the setup takes little space to reduce the amount of wiring needed for driving tests.

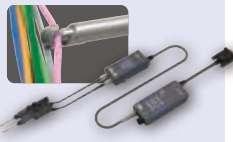

## Support for multichannel measurement: receive up to 500 channels with 1 module

As a result of electrification, automobiles now use enormous quantities of data internally, and the amount of data on CAN buses consequently is growing. A single CAN module can capture up to 500 channels\*1 of data. The LR8450 can accommodate up to four modules, allowing you to measure up to 2000 channels of CAN data. Each channel can collect information for one signal \*1 With a recording interval of 100 ms

## Convenient function 1 Notification when a specific ID is received

Start and stop measurement when a CAN signal with a specific ID occurs

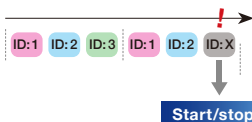

## Convenient function 2 Bit mask trigger function

Set a trigger that corresponds to a particular pattern with the bit mask trigger function. For example, this function can be used when you wish to start recording when a control signal exhibits the specific pattern of "10101010."

## Convenient function 3 Sending user-defined CAN frames

Sometimes it's necessary to send a CAN signal to an ECU in advance so that the ECU will output data to the CAN bus. With the U8555, you can send user-defined CAN frames to a CAN bus while performing CAN measurement.

### One-time transmission

When you need to send a CAN control frame once in order to change an ECU's operating mode

### Repeated transmission

When an ECU won't output the value you wish to capture unless you send specific CAN data each time





**CAN UNIT U8555**  
CAN and CAN FD input or output



**WIRELESS CAN UNIT LR8535**  
CAN and CAN FD input only



Driving tests of automobiles

## CAN output

U8555 only

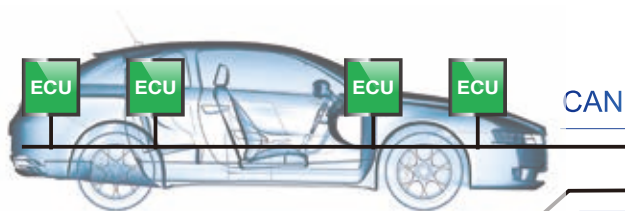

**Capturing measurement data**  
Measure temperature and vibration in the vehicle.

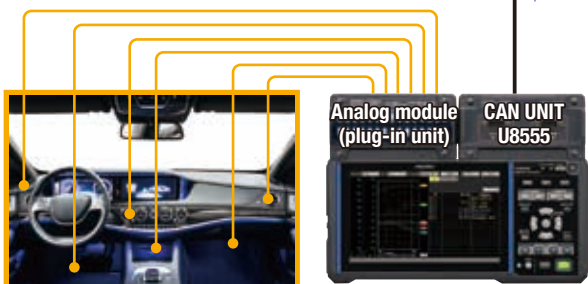

Temperature measurement: max. 100 S/s (10 ms)

### High-speed output

Higher vehicle performance is creating a demand for faster, more complex communications control. Thanks to its ability to output voltage and temperature measured values to the CAN bus with a data refresh period as short as 1 ms (1 kS/s), the LR8450 can accommodate the need to acquire measurement data for systems that require real-time control.

### CAN output

Output data measured by modules as CAN signals



Combine all data as CAN data onto your system of choice

Enjoy managing CAN data and measured analog data on one CAN system of your choice!

Send analog data measured using a plug-in module over a CAN bus. This capability lets you integrate reliable data acquired using calibrated instruments with data on the CAN bus and upstream systems to realize unified management.

Only data measured with a plug-in measurement module can be output as CAN signals. Data measured with a wireless module cannot be output.

### CAN output

Generate CAN signal output as an alarm when a malfunction is detected

Set a threshold for analog measured values like voltage or temperature so that the CAN signal is output if the threshold is exceeded. This feature lets you use a CAN logging system to detect malfunctions.

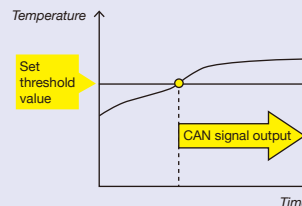

## CAN Editor (standard CAN configuration software accessory)

Install this software from the application disc that comes with the MEMORY HiLOGGER LR8450 onto a PC to easily configure CAN Unit settings.

### Setting method Online or offline

Save settings configured using the CAN Editor in the CES format and then load them with the LR8450. You can also configure instruments offline when a LAN or USB connection is difficult to establish.

### Receive mode Loading DBC files

In addition to setting up channels manually, you can complete CAN communication definition settings simply by loading a DBC file.

### Output mode Automatically configuring output targets

Creating output communication definitions one channel at a time for a logger that's handling a large number of channels is extremely time-consuming. With the CAN Editor, you need only specify the start ID and click the "Configure Automatically" button to complete all communication definitions. Those definitions can then be output as a DBC file and loaded onto an upstream system to complete the configuration process.

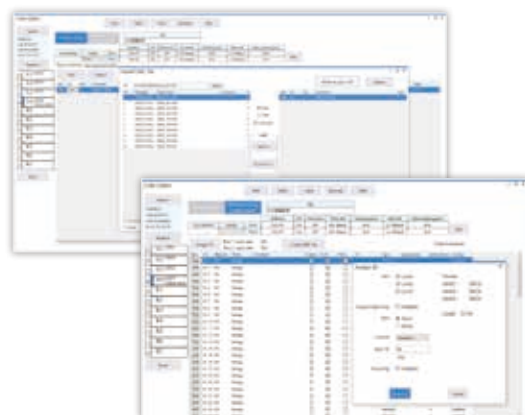

# Wireless for ease of use

## Collect data from dispersed locations all at the same time

The LR8450-01 can simultaneously collect measurement data from wireless units installed on various test equipment.

- Collect measurement data from multiple locations with a single logger
- Manage data in a single time sequence
- Units can be placed in confined locations
- Check the display during measurement



Install wireless units in testing equipment

\* Better connection may be attained from placing the LR8450-01 and/or wireless module on the floor or ground for a shorter communication distance.

## Peace of mind in the event of an interruption in power or wireless connectivity

### Peace of mind if communications are temporarily interrupted

#### Buffer memory holds up to 5 min.\*1 of measurement data

Each wireless unit has a built-in buffer memory that can hold up to 5 min.\*1 of measurement data. Data are resent along with more recent measurement data once communications resume, after which the data are restored inside the LR8450-01\*2.

The system can be configured to output an alarm if communications are interrupted or if a module encounters a low-battery state.

\*1 The duration for which measurement data can be maintained does not vary with the recording interval (up to a maximum of 5 min.)

\*2 Data collected using the Logger Utility software measurement cannot be restored in this manner.

### Battery operation

#### Use modules in locations where there's no AC power

Example:

The wireless VOLTAGE/TEMP UNIT LR8530 can operate for about 9 hours on battery power. If the unit is charged at night, it can operate on just the battery pack during the day.

Using the Battery Pack Z1007

Wireless module model	Continuous operating time
LR8530	Approx. 9 hr.
LR8531	Approx. 7 hr.
LR8532	Approx. 9 hr.
LR8533	Approx. 9 hr.
LR8534	Approx. 5 hr.
LR8535	Approx. 10 hr.*

\*Approx. 5 hours when using two non-contact CAN sensors.



### Peace of mind in the event of a power outage during measurement

#### Install a battery pack for peace of mind

If you've installed a battery pack in a module that's being powered by an AC adapter, the unit will automatically switch to battery power in the event of an outage so that the LR8450-01 can continue making measurements.



## Make measurements in locations where it would be difficult to route wires

Work time can be reduced using the LR8450-01 and wireless modules, since only minimal wiring is required. If the measurement target is located in a lab, this approach eliminates the need for wiring and avoids having to drill holes in the walls of the monitoring room where data is being checked.

Inside a room, or outside, you can make measurements with the door closed.



## Simple registration of wireless modules

Wireless modules, located within the range, that are not connected to another LR8450-01, can be automatically detected. Simply choose the module you wish to register from the list.



## Check the unused wireless LAN channels and select the wireless channel to use

You can reduce interference from other wireless devices by using an open channel (wireless frequency range being used by wireless devices in the area). Check for open channels on the instrument's screen.

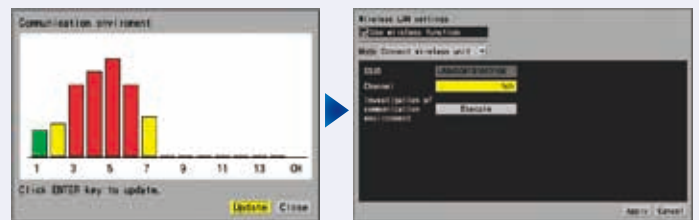

## Observe data from a remote location using a PC or a tablet

By connecting the LR8450-01 to a PC or a tablet via wireless LAN, you can control the instrument remotely using the built-in HTTP server or obtain older data files using the built-in FTP server.

(You cannot use Logger Utility when using Station Mode or Access Point Mode. See below.)

### Station mode

Connect wirelessly to a third-party access point (AP).

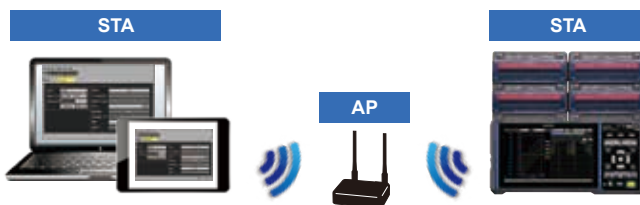

### Access point mode

The LR8450 can be directly connected to a PC via wireless LAN.



# Easy-to-read display of measured values

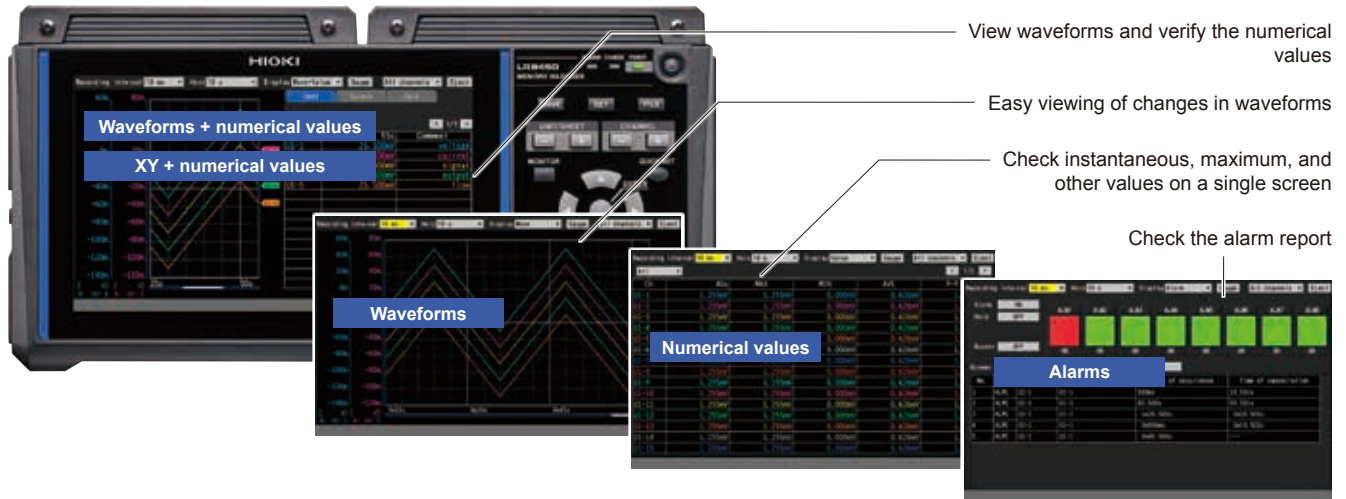

# External control terminals and interfaces to accommodate a broad range of use cases



Motor speed, flow rate integration, etc.

## 8 channel pulse measurement

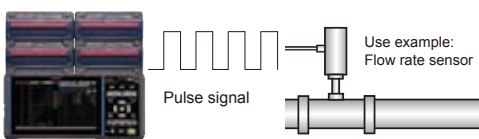

In "Revolve" mode, monitor production equipment by measuring the variations in revolution speed of motors or drills. In "Count" mode, identify operation status by acquiring integrated power or flow rate.

Two terminals for voltage outputs (5, 12, or 24 V)

## Supplying power to the sensors

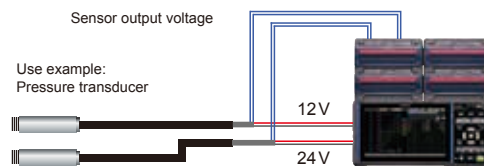

The LR450/LR450-01 provides two output terminals for voltages, each of which can supply 100 mA current, eliminating the need for a separate sensor power supply. You can select 5 V, 12 V, or 24 V from the VOUTPUT1 terminal and 5 V or 12 V from the VOUTPUT2 terminal.

Useful in preventive maintenance

## 8 channel alarm outputs

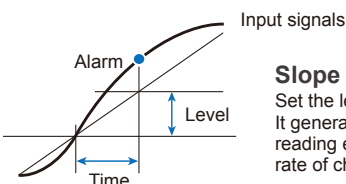

You can set alarm output for eight channels. You can set a level, a window, a slope, and a logic pattern on channels you wish to monitor.

Replace storage media during real-time saving

## No need to stop recording

When you remove the storage media while recording data, and reinsert it, data remaining in the internal buffer memory will continue to be stored in a new and different file.



## Extensive calculation functions

### Numerical calculation function

In addition to the maximum and minimum value calculation functions provided by previous models, the LR8450/LR8450-01 offers an extensive range of calculations, including on/off time, count, and usage ratio.



#### Types of calculations

- Average value
- Peak-to-peak value
- Maximum value
- Minimum value
- Time at which maximum value occurred
- Time at which minimum value occurred
- Integration
- Aggregation
- Usage ratio
- On time
- Off time
- On count
- Off count

### Waveform calculation function

Calculate data while measurement continues and display calculated waveforms in real time. Calculation results are saved on a separate and dedicated calculation channel.

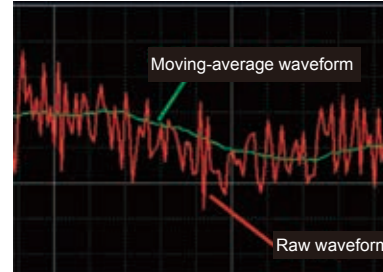

#### Types of calculations

- Basic arithmetic operations
- Aggregation
- Simple average
- Moving average
- Integration

## Recording over extended periods of time without interruption

Collect data on a storage device (SD memory card or USB drive) while measuring continues. The ability to segment files by hour or day without stopping measurement is convenient when you need to review data later.

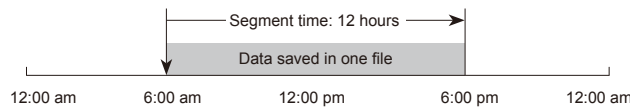

### Maximum recording time (estimate)

#### Example: Recording 30 analog channels with 2 modules (no alarm output or waveform processing)

Because the header portion of waveform files is not included in capacity calculations, expected actual maximum time is about 90% of those in the tables. The maximum recording time varies with the number of measurement channels. Recording times are doubled if the number of measurement channels shown in the table is halved.

When recording 30 analog channels with two U8550/U8551 modules or one U8552 module (no alarm output, no waveform processing)  
When recording 30 analog channels with two LR8530/LR8531 modules or one LR8532 module (no alarm output, no waveform processing)

Recording intervals	Internal buffer memory (512 MB)	SD MEMORY CARD Z4001 (2 GB)	SD MEMORY CARD Z4003 (8 GB)	USB DRIVE Z4006 (16 GB)
10 ms	1 d	3 d 20 h	15 d 8 h	30 d 12 h
100 ms	10 d 8 h	38 d 18 h	153 d 9 h	305 d 5 h
1 s	103 d 13 h	387 d 12 h	1,533 d 21 h	3,052 d 9 h
10 s	500 d	3,875 d 6 h	15,339 d 3 h	30,523 d 19 h

When recording 20 channels with four U8553 modules or U8554 modules (no alarm output, no waveform processing)

When recording 20 channels with four U8553 modules or LR8534 modules (no alarm output, no waveform processing)

Recording intervals	Internal buffer memory (512 MB)	SD MEMORY CARD Z4001 (2 GB)	SD MEMORY CARD Z4003 (8 GB)	USB DRIVE Z4006 (16 GB)
1 ms	3 h 43 min	13 h 56 min	2 d 7 h	4 d 13 h
10 ms	1 d 13 h	5 d 19 h	23 d	45 d 18 h
100 ms	15 d 12 h	58 d 3 h	230 d 2 h	457 d 20 h
1 s	155 d 8 h	581 d 7 h	2,300 d 21 h	4,578 d 13 h
10 s	500 d	5,813 d 1 h	23,008 d 20 h	45,785 d 20 h

When recording 330 channels with four U8552 modules and seven LR8532 modules (no alarm output, no waveform processing)

Recording intervals	Internal buffer memory (512 MB)	SD MEMORY CARD Z4001 (2 GB)	SD MEMORY CARD Z4003 (8 GB)	USB DRIVE Z4006 (16 GB)
20 ms	4 h 8 min	15 h 28 min	2 d 13 h	5 d 2 h
100 ms	20 h 42 min	3 d 5 h	12 d 18 h	25 d 10 h
1 s	8 d 15 h	32 d 6 h	127 d 19 h	254 d 8 h
10 s	86 d	322 d 16 h	1,277 d 23 h	2,543 d 9 h



# Control the instrument remotely and capture data on a PC

## HTTP server function

### Control the instrument remotely from a PC

Use a standard Web browser to control the LR8450/LR8450-01, start and stop measurement, then enter comments.

### Use a mouse to operate waveforms displayed on a PC

Enjoy intuitive mouse-based control, including waveform scrolling and cursor operations.

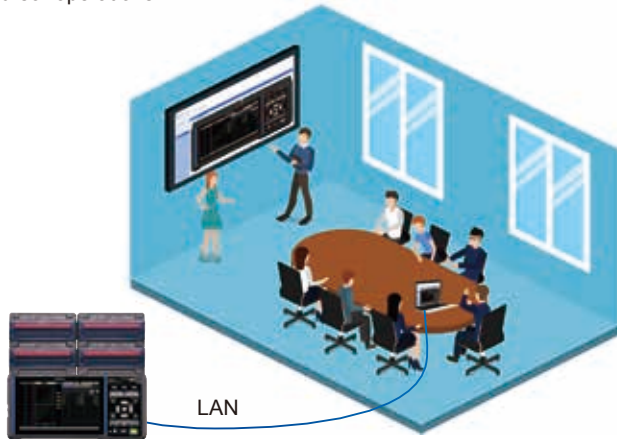

## FTP server function

### Download data files onto a PC

Your PC can get files from inside the SD memory card or USB drive inserted to the LR8450/LR8450-01.

## FTP client

### Automatically transfer data files to an FTP server

Automatically transmit files to an FTP server from the SD memory card or in the USB drive inserted to the LR8450/LR8450-01.

## NTP client function

### Set the logger's clock

Set the clock in the LR8450/LR8450-01 and synchronize it to an NTP server on the network.

## E-mail transmission function

### Receive email notices on errors and other information

Receive emails to your PC or mobile phone when there is a communication loss and when an error occurs during measurement and wireless module communications. It can also send instantaneous values by e-mail periodically.

## Use with other tools

**NEW**

### Output measured values using XCP on Ethernet

The LR8450 supports XCP slave operation based on the XCP protocol, a standard developed by the Association for Standardisation of Automation and Measuring Systems (ASAM). You can perform control to start and stop measurement and acquire measured values using an XCP master. (Measured values from CAN modules cannot be output.)

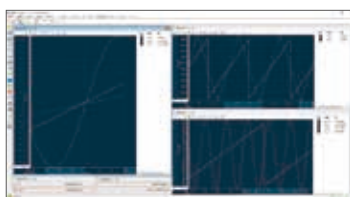

LAN

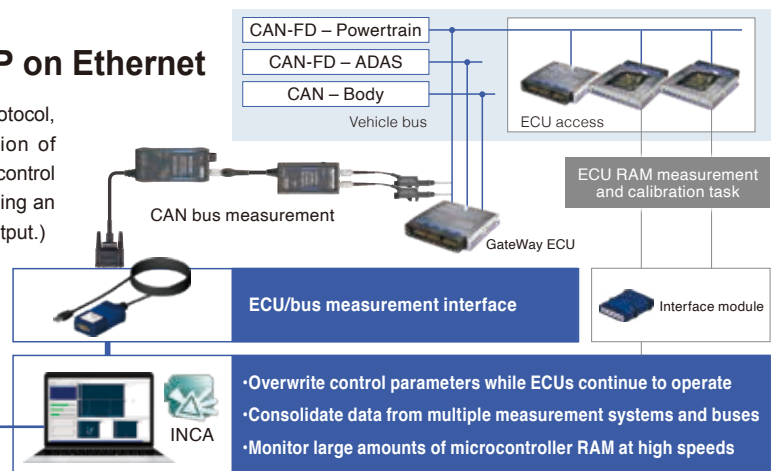

**NEW**

### Load data using MDF-compatible waveform viewers

Voltage, temperature, strain, CAN, and other measurement data captured by the LR8450 can be saved in the Measurement Data Format (MDF) and loaded by other software that supports the format.

#### Commercially available software

##### FAMOS

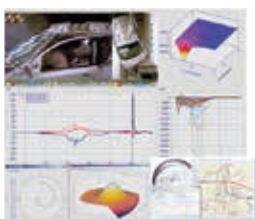

- More than 400 calculation processing variables
- Easy report creation functionality

##### FlexPro



- High-speed search and processing of large volumes of data
- Share analysis templates within your company

##### NI DIAdem



- Functionality ranging from searching and loading of data to analyzing and creating of reports
- Dialog-based interface

##### OS-2000

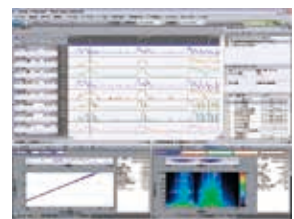

- Freely edit large data that cannot be handled by Excel
- Simultaneously display the waveforms which have different frequencies

# PC-based measurement makes measurement work more efficient

## Logger Utility (standard accessory)

Collect data at sampling speeds of up to 10 ms on a PC



Record data on a PC in real time using the Logger Utility application software, a standard accessory. You can even scroll waveforms backwards to view older data while recording is in progress. A real-time measurement is supported for recording intervals of 10 ms or longer.

U8555 and LR8535 CAN Unit real-time measurement and viewing of waveform data are not supported. Please use the GENNECT One software for real time viewing of CAN data by the U8555 and LR8535.

Recording interval	Simultaneous recording	No. of connected units	Save destination	Connection method
10 ms	2035 channels	up to 5	PC	LAN/USB

+ 60 waveform calculation channels



Simultaneously log data from five LR8450 instruments at a speed of up to 10 ms.



Display logged data in real time as a graph.

## GENNECT One

Make simultaneous measurements using multiple instruments

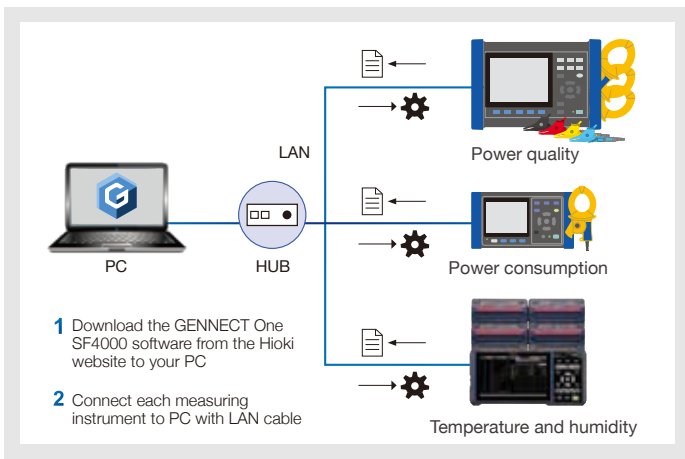

Aggregate measurement data from not only loggers, but also waveform recorders, power meters, and other instruments onto a single PC.

Display this measurement data on a single graph in real time. Summarize it in daily and monthly reports. Manage in a centralized manner. GENNECT One is a Windows application that specializes in aggregating measurement data.

Data including CAN data from the U8555 and LR8535 can be viewed and measured in real time (logging function, dashboard function). Real time measurement and viewing of CAN data will be available from the LR8450's next firmware update around mid or late 2022.

GENNECT One is a free application.  
Access this 2D Code for details and downloads.



Recording interval	Simultaneous recording	Total No. of connected devices	Save destination	Connection method
1 s	512 channels	up to 15*	PC	LAN

\*Up to 30 devices can be connected when using only the logging or dashboard functions



Simultaneously log data from instruments like recorders and power meters as frequently as 1 s.



Display logged data in real time as a graph. Automatically create CSV files and daily/monthly reports.



Graphically display measured values using the dashboard function. Visually identify anomalies.



Download instrument data files saved on instruments' SD cards.



Change instrument settings remotely.

# Specifications

LR8450, LR8450-01 Memory HiLogger	
General specifications, basic specifications	
Product warranty period	3 years
Accuracy guarantee period	1 year (accuracy guarantee duration after adjustment made by Hioki: 1 year)
Maximum number of connectable modules	4 plug-in modules + 7 wireless modules* *LR8450-01 only No more than 4 CAN modules (U8555 and/or LR8535) can be connected.
Connectable modules (plug-in modules)	U8550 VOLTAGE/TEMP UNIT    U8553 HIGH SPEED VOLTAGE UNIT U8551 UNIVERSAL UNIT        U8554 STRAIN UNIT U8552 VOLTAGE/TEMP UNIT    U8555 CAN UNIT
Connectable modules (wireless modules) (LR8450-01 only)	LR8530 WIRELESS VOLTAGE/TEMP UNIT LR8531 WIRELESS UNIVERSAL UNIT LR8532 WIRELESS VOLTAGE/TEMP UNIT LR8533 WIRELESS HIGH SPEED VOLTAGE UNIT LR8534 WIRELESS STRAIN UNIT LR8535 WIRELESS CAN UNIT
Internal buffer memory	Volatile memory, 256 M-words
Clock functionality	Auto-calendar, automatic leap year recognition, 24-hour clock
Clock precision (precision of clock displayed by instrument as well as start/stop times)	±1.0 s/day (at 23°C) Time can be synchronized with an NTP server to which the instrument is connected.
Time axis accuracy	±0.2 s/day (at 23°C)
Backup battery service life	For clock, at least 10 years (reference value at 23°C)
Operating environment	Indoors, pollution degree 2, altitude up to 2000 m
Operating temperature and humidity range	-10°C to 50°C (14°F to 122°F), 80% RH or less (non-condensing) (charging temperature range: 5°C to 35°C)
Storage temperature and humidity range	-20°C to 60°C (-4°F to 140°F), 80% RH or less (non-condensing)
Dimensions	Without any modules: 272W × 145H × 43D mm (10.72"W × 5.71"H × 1.69"D) (excluding protrusions) With 2 modules: 272W × 198H × 63D mm (10.71"W × 7.8"H × 2.78"D) (excluding protrusions) With 4 modules: 272W × 252H × 63D mm (10.71"W × 9.92"H × 2.48"D) (excluding protruding parts)
Mass	Approx. 1108 g (39.08 oz.) (excluding battery pack)
Standards	Safety: EN61010 EMC: EN61326 Class A
Vibration resistance	JIS D 1601:1995:1995 5.3 (1) Class 1: Passenger vehicles, conditions: Class A equivalent
Accessories	Quick start manual, LOGGER application disc (quick start manual, instruction manual, logger utility, logger utility instruction manual, CAN editor, CAN editor instruction manual, communication instruction manual), USB cable, AC adapter Z1014, precautions concerning use of equipment that emits radio waves (LR8450-01 only)

Display	
Display	7-inch TFT color LCD (WVGA 800 × 480 dots)
Display resolution (with waveform display selected)	Max. 20 divisions (horizontal axis) × 10 divisions (vertical axis) (1 division = 36 dots [horizontal axis] × 36 dots [vertical axis])
Display language	Japanese, English, Chinese, Korean
Backlight service life	Approx. 100,000 h (reference value at 23°C)
Backlight saver	Turns off backlight when no key is operated for a set amount of time
Backlight brightness	5 levels (user-selectable)
Waveform background color	Dark/light (user-selectable)

Power supply		
Power supply	AC adapter	Z1014 AC Adapter (12 V DC ±10%) AC Adapter rated supply voltage: 100 V to 240 V AC (assuming voltage fluctuation of ±10%) AC Adapter rated power supply frequency: 50/60 Hz
	Battery	LR8450 accommodates 2 batteries Z1007 Battery pack (when used with AC Adapter, AC Adapter takes priority) Li-ion, 7.2 V, 2170 mAh
	External power supply	10 V to 30 V DC
Power consumption	Normal power consumption	Using Z1014 AC adapter or 12 V DC external power supply, without Battery Pack With LCD at maximum brightness: 8.5 VA (instrument only) With LCD backlight off: 7 VA (instrument only)
	Maximum rated power	When using the Z1014 AC adapter 95 VA (including AC adapter) When using a 30 V DC external power supply 28 VA (while charging battery with LCD at maximum brightness) When using the Z1007 Battery pack 20 VA (with LCD at maximum brightness)
Continuous operating time	Battery	With one Z1007 Battery pack: approx. 2 h (reference value at 23°C) With two Z1007 Battery packs: approx. 4 h (reference value at 23°C) Conditions: with one U8551 Universal Unit connected, backlight on, voltage output off, and Z4006 connected
Charging functionality	Charging is available when the Z1007 Battery pack is attached and the AC adapter is connected. Charging time: Approx. 7 h (reference value at 23°C)	

Interface specifications	
The LAN interface and USB interface (function) cannot be used at the same time	
LAN interface	IEEE 802.3 Ethernet, automatic 100Base-TX/1000Base-T detection Auto MDI-X, DHCP, DNS supported Connector: RJ-45 Maximum cable length: 100 m LAN functionality: Acquiring data and setting recording conditions with Logger Utility

LAN interface	LAN functionality:	Configuring settings and controlling recording using communications commands Manually acquiring data using the FTP server: Acquiring files from a connected SD Memory Card or USB Drive Automatically sending data via FTP (FTP client) Transferring files saved on a connected SD Memory Card or USB Drive Waveform files while measurement is in progress: binary, text, MDF Waveform files after measurement has finished: binary, text, MDF, numerical calculation result files HTTP server function Control mode (one instrument): Displaying screen and remotely controlling instrument and modules, current measured value display, starting/stopping measurement, acquiring data via FTP, setting comments, updating instrument and modules Browsing mode (up to four instruments): Displaying screen, measurement status, and comments Email transmission Start trigger, stop trigger, alarm, power outage recovery, internal buffer, memory full, media full, wireless unit communication interruption, battery low, and periodic mail transmission. Instantaneous values can be attached for start trigger, stop trigger, alarm, and periodic transmission. Emails can be sent regularly at the following intervals: 30 min., 1 h, 12 h, or 1 day. NTP client function Time synchronization with an NTP server Regular synchronization intervals: 1 h, 1 day Pre-measurement synchronization function
	Wireless LAN interface (LR8450-01 only)	IEEE 802.11b/g/n Communications range: 30 m, line of sight Encryption function: WPA-PSK/WPA2-PSK, TKIP/AES Usable channels: 1 to 11 Auto-connect function: wireless LAN function can be toggled on and off. Supported modes: access point, station, wireless module connectivity Devices that can be connected in wireless module connectivity mode: wireless modules or PC/tablet You can use either a wireless module or PC/tablet with wireless connection
USB interface (host)	LAN functionality:	Configuring settings and controlling recording using communications commands Manually acquiring data using the FTP server Acquiring files from a connected SD Memory Card or USB Drive Automatically sending data via FTP (FTP client) Transferring files saved on a connected SD Memory Card or USB Drive HTTP server function Control mode (one instrument): Displaying screen and remotely controlling instrument and modules, current measured value display, starting/stopping measurement, acquiring data via FTP, configuring comment, updating the instrument and modules Browsing mode (up to four instruments): Displaying screen, current measured value display, measurement status, and comments Email transmission Start trigger, stop trigger, alarm, power outage recovery, internal buffer, memory full, media full, wireless unit communication interruption, low battery, and periodic mail transmission. Instantaneous values can be attached for start trigger, stop trigger, alarm, and periodic transmission. Emails can be sent regularly at the following intervals: 30 min, 1 h, 12 h, 1 day. NTP client function Time synchronization with an NTP server Regular synchronization intervals: 1 h, 1 day Pre-measurement synchronization function
	USB interface (function)	Standard compliance: USB 2.0 compliant Connectors: Series A receptacle × 2 Guaranteed-operation options: Z4006 USB drive (16 GB) File system: FAT16, FAT32 Connectable devices: keyboard, mouse, hub (1 layer), USB drive (1 port only)
SD card slot	USB standard: USB 2.0 compliant Connector: series mini-B receptacle USB functionality: data acquisition, condition settings used with the Logger Utility software (bundled) Configuring settings and controlling recording using communications commands USB drive mode: transferring data from a connected SD memory card to a computer	
	Standard compliance: SD standard-compliant slot × 1 (with SD memory card/SDHC memory card support) Guaranteed-operation options: Z4001 (2 GB), Z4003 (8 GB) File system: FAT16, FAT32	

External control terminals				
Terminal block	Push-button type terminal block			
External I/O	Number of terminals	4, non-isolated (same GND as instrument)		
		Input	Input voltage	0 V to 10 V DC
	Output	Slope	Rising/falling (user-selectable)	
		Functionality	Choose from off, start, stop, start/stop, trigger input, event input	
		Output format	Open-drain output (with 5 V voltage output)	
		Maximum switching capacity	5 V to 10 V DC, 200 mA	
Functionality	Trigger output			
Alarm output	Output format	Open-drain output (with 5 V voltage output)		
	Maximum switching capacity	5 V to 30 V DC, 200 mA		
	Number of terminals	8, non-isolated (same GND as instrument)		
Voltage output	Output voltage	Off, 5 V, 12 V, 24 V* (user-selectable) Supply current: max. 100 mA each *24 V output can be selected for the VOUT-PUT1 terminal only		
	Number of terminals	2, non-isolated (same GND as instrument)		
GND terminal	Number of terminals	10 (common GND)		



Recording	
Recording mode	Normal
Recording intervals	1 ms*, 2 ms*, 5 ms*, 10 ms, 20 ms, 50 ms, 100 ms, 200 ms, 500 ms, 1 s, 2 s, 5 s, 10 s, 20 s, 30 s, 1 min., 2 min., 5 min., 10 min., 20 min., 30 min., 1 h * Setting available only when using a module with data refresh intervals that include 1 ms
Data refresh interval	Automatically- or user-selected value per module
Repeat recording	On/off (user-selectable)
Specified time/continuous	Specified time: recording time is set in days, hours, minutes, and seconds. Time can be set up to maximum capacity of internal buffer memory. (total 256 mega-data-points) Continuous: recording is performed once until it is stopped. If maximum capacity of internal buffer memory is exceeded, memory will be overwritten.
Waveform recording	Last 256 mega-data-points are saved in internal buffer memory. Scroll through and view data stored in internal buffer memory. Alarm source data recording can be toggled on and off.
Backup of recorded data	None

Display	
Sheet function	Display sheets can be switched between all channels and individual modules. Max. number of channels on all-channel display sheet: 120 analog/CAN channels, 30 waveform calculation channels, 8 pulse/logic channels, 8 alarm channels
Waveform display screen	Time-axis waveform display: simultaneous display of gages and settings (channel settings and display settings) Simultaneous display of time-axis waveforms and values: instantaneous values, cursor values, or numerical calculation values (user-switchable) Numerical display: simultaneous display of instantaneous values and statistical values Alarm display: display of alarm status and alarm history
Display format	Time-axis waveform display: 1 screen X-Y waveform display: 1 screen
X-Y composite	Composite up to 8 waveforms.
Numerical display format	SI units, decimal, or exponent (user-selectable) When decimal is selected, number of decimal places to display can be set (values will then be rounded to set number of places).
Waveform colors	24 colors
Zooming in and out on the waveform display	Horizontal axis: 2 ms to 1 day/division Vertical axis: Number of divisions per screen: 10 Setting method: Select position or upper and lower limits for each channel. (Waveform calculation channels: upper and lower limits only) When setting by position: set zoom factor and zero position. Zoom factor: 1/2 x, 1 x, 2 x, 5 x, 10 x, 20 x, 50 x, 100 x Zero position: -50% to 150% (with a zoom factor of 1 x) When setting by upper/lower limit: set upper and lower limit.
Waveform scrolling	Display can be scrolled left and right both during recording and while recording is stopped (during waveform rendering only)
Monitor display	Check instantaneous values and waveforms without recording data to memory (values and waveforms can be displayed while waiting for a trigger)
Wireless module status display (LR8450-01 only)	Indicates the battery remaining and the radio-wave strength, in the four levels, of the wirelessly connected modules

Files	
Save destinations	SD memory card or USB drive (user-selectable) (only storage media sold by Hioki are guaranteed for operation)
File names	Up to 8 single-byte characters Automatic numbering, dating, assignment of title comment (user-selectable)
Auto saving	Waveform data (real-time saving): off, binary format, text format, or MDF format (user-selectable) Numerical calculation results (saved after recording): off or text format (user-selectable) When text format is selected, choose whether to save all calculations in one file or to save each calculation in its own file.
Delete and save	On/off (user-selectable) Off: system will stop saving data when SD memory card or USB drive starts to run out of available space. On: when SD memory card or USB drive starts to run out of available space, system will delete oldest waveform file (binary, text, or MDF) and then continue saving data.
Folder Splitting	No segmentation, 1 day, 1 week, or 1 month (user-selectable)
File splitting	Disabled, enabled, or timed (user-selectable) Disabled: data for each recording session is saved in its own file. Enabled: data for each set period of time is saved in its own file, starting with the start of measurement. Segmentation time: day, hour, or minute (user-selectable) Timed: data will be segmented at intervals of the segment time based on the previously set reference time and saved in separate files. Reference time: set in hours and minutes. Split time: 1 min, 2 min, 5 min, 10 min, 15 min, 20 min, 30 min, 1 h, 2 h, 3 h, 4 h, 6 h, 8 h, 12 h, 1 d
External media eject (SD memory card or USB drive)	External media can be ejected during real-time saving by activating a button on the screen and confirming a message.
Data protection	Yes (valid only when Z1007 Battery Pack is installed) If remaining battery life declines during real-time saving, system will close file and stop saving data (although measurement operation will continue).
Manual saving	Data is saved when SAVE key is pressed. Choose either selective save or immediate save as an operation to perform when SAVE key is pressed.
Decimation (text format only)	Decimate and save: Off, or a value from 1/2 to 1/100,000 (user-selectable) Saved data: Select from instantaneous values and statistical values. When statistical values are selected: instantaneous values, maximum values, minimum values, and average values will be saved for the thinning interval.

Loading data	
Loading saved data	Specifies a position and then loads up to 256 mega-data-points of previously saved text-format data.

Calculations		
Numerical calculations	Number of calculations	Up to 10 calculations simultaneously
	Calculation content	Average value, peak-to-peak value, maximum value, maximum value time, minimum value, minimum value time, integration <sup>*1</sup> , aggregation <sup>*1</sup> , usage ratio <sup>*2</sup> , on time <sup>*2</sup> , off time <sup>*2</sup> , on count <sup>*2</sup> , off count <sup>*2</sup> *1: total, positive, negative, or absolute value (user-selectable) *2: threshold values can be set for individual channels
	Calculation range	During recording: calculations performed for all data during recording After recording has stopped: calculations performed for all data in the internal buffer memory, or for data in a calculation range specified by the A/B cursors (on the vertical axis)
Time split calculation		Disabled, enabled, or timed (user-selectable) Disabled: calculations performed for all data during recording Enabled: data for each segment of time, starting with the start of measurement Segmentation time: set DD:HH:MM format Timed: calculations will be made at intervals of the segment time based on the previously set reference time. Reference time: set in hours and minutes. Split time: 1 min, 2 min, 5 min, 10 min, 15 min, 20 min, 30 min, 1 h, 2 h, 3 h, 4 h, 6 h, 8 h, 12 h, 1 d
	Waveform calculations	Arithmetic operations among channels Moving average, simple average, aggregation, and integration of any channel. Calculated values are recorded as data for calculation channels (W1 through W30). (Calculations are performed at the same time as measurement. Values cannot be recalculated after measurement.)

Triggers	
Trigger method	Digital comparison method
Trigger timing	Start, stop, or start & stop
Trigger conditions	AND/OR operation performed on trigger source, interval trigger, or external trigger When triggers are disabled, free run
Trigger sources	Analog, pulse, logic, waveform calculations, CAN (max. 100)
Trigger types	Analog, pulse, waveform calculations, CAN Level triggers: trigger activated by arising or falling edge at a set level Window triggers: it is set by trigger level upper limit and lower limit. Trigger activated when value leaves area or when value enters area Logic, CAN Trigger activated when patterns of 1/0/X match (where "X" indicates either)
Interval triggers	Trigger activated for set recording interval after setting days/hours/minutes/seconds
External triggers	Trigger activated by rising or falling edge at set level in external input signal. Rising/falling (user-selectable)
Trigger response time	When using plug-in units: (recording interval or data refresh interval, whichever is longer) × 2 + 1 ms + analog response time <sup>*1</sup> When using wireless units (LR8450-01 only): (recording interval or data refresh time, whichever is longer) × 2 + wireless response time <sup>*2</sup> + analog response time <sup>*1</sup> *1: depends on filter settings (U8554 with a data refresh interval of 5 ms and low-pass filter of 120 Hz). *2: when the radio-wave state is in good condition, 1s.
Trigger level resolution	Analog: 0.1% f.s. (f.s. = 10 divisions) Pulse: Count = 1c, rotational speed = 1/n (where n = pulse count per rotation setting)
Pre-triggers	Set day/hours/minutes/seconds. Can be set during real-time saving.

Alarms	
Alarm conditions	Set separately for ALM1 to ALM8 System will output an alarm when any of the following conditions are satisfied: • AND/OR operation performed on alarm sources • Low battery • Thermocouple burnout • Wireless error (LR8450-01 only)
Alarm sources	Analog, pulse, logic, waveform calculations, CAN (max. 100)
Wireless error (LR8450-01 only)	Alarm output when a wireless communication error with a wireless module is detected Off/now/3 min (user-selectable) Now: outputs an alarm upon a communications disruption 3 min: outputs an alarm if a communication disruption continues for 3 minutes.
Low remaining battery life	Alarm output when low remaining battery life is detected for the instrument or a wireless module.
Thermocouple burnout	Alarm output when a thermocouple burnout occurs (when Tc burnout detection setting is enabled)
Types of alarms	Analog, pulse, waveform calculation, CAN Level: system will output an alarm following a rising or falling edge at set level Window: set upper limit and lower limit System will output an alarm when value leaves area or when value enters area Slope: set level and time. The system will output an alarm when the rate of change (level per unit time) continues to exceed the specified change rate during the set time interval. Logic: System will output an alarm when patterns of 1/0/X match (where "X" indicates either)
Alarm filter	Apply a filter to results of AND/OR operations performed on alarm sources. Set based on sample count (off, 2 to 1000). System will output an alarm if alarm state continues for set number of samples

Alarm retention	On/off (user-selectable) Clear alarms: when alarm retention is on, alarms will be cleared without stopping recording.
Alarm tone	On/off (user-selectable)
Alarm output response time	When using plug-in units: (recording interval or data refresh interval, whichever is longer) × 2 + 1 ms + analog response time*1 When using wireless units (LR8450-01 only): (recording interval or data refresh interval, whichever is longer) × 2 + wireless response time*2 + analog response time*1 *1: depending on filter settings (U8554 with a data refresh interval of 5 ms and low-pass filter of 120 Hz). *2: when the radio-wave state is in good condition, 1s.

Other functionality	
Even mark function	Number of inputs   Up to 1000 inputs per measurement
Waveform search function	Search conditions   Search by choosing level, window, maximum value, minimum value, local maximum value, or local minimum value.
	Search range   All data in internal buffer memory or data between A/B cursors (on vertical axis)
	Search targets   Analog, pulse, logic, waveform calculations
Jump function	Specify event mark, A/B cursor position, trigger point, or waveform display position to display that section in center of waveform screen.
Cursor measurement function	Cursor display   All channels or specified channels (user-selectable)
	Cursor movement   A, B, or simultaneous (user-selectable)
	Types of cursors   Vertical or horizontal (user-selectable)
Scaling function	Scaling settings can be configured separately for each channel
Comment entry function	Enter titles and channel-specific comments
Start state retention function	On/off (user-selectable)
Auto-start function	On/off (user-selectable)
Functionality for saving setting conditions	Up to five groups of setting conditions can be saved in the instrument's internal backup memory.
Auto setup function	Setting conditions saved in the instrument's memory or on an SD memory card or a USB drive can be automatically loaded when the instrument is powered on. If there are setting conditions stored in the instrument's memory as well as on an SD memory card and a USB drive, setting conditions have the following precedence: instrument's memory, SD memory card, and USB drive.
Prevention of inadvertent START/STOP key operation	When START or STOP key is pressed, system will display a message asking if user wishes to start or stop measurement. Confirmation message: enable/disable (user-selectable)
Key lock function	Disables operation keys
Beep tone	On/off (user-selectable)
Self-check function	Can check keys, LCD, ROM/RAM, LAN, media, and modules.
Display of horizontal axis (time values)	Horizontal axis (time value) display can be set to time, date, or data point count. These are reflected in saved text data.
Measurement start/stop time specification function	Set measurement start and stop conditions. Specified time: set start time and stop time (year, month, day, hour, and minute)
Configuration navigation (quick set) function	Wireless module registration guide (LR8450-01 only), wireless connectivity troubleshooting guide (LR8450-01 only), connection diagram display (strain gage, external terminals), loading setting conditions
Power supply frequency filter function	50/60 Hz selection

Input	
Pulse/logic input	
Number of channels	8 channels (common GND, non-isolated) Exclusive setting for pulse/logic input for individual channels
Terminal block	Push-button type terminal block
Adaptive input format	Non-voltage contact, open collector (PNP open collector requires external resistor), or voltage input
Maximum input voltage	0 V to 42 V DC
Input resistance	1.1 MΩ ±5%
Detection level	2 levels (user-selectable) High: 1.0 V or greater; low: 0 to 0.5 V High: 4.0 V or greater; low: 0 to 1.5 V

Pulse input																
Measurement range, resolution																
	<table border="1"> <thead> <tr> <th>Measurement target</th> <th>Range</th> <th>Maximum resolution</th> <th>Measurable range</th> </tr> </thead> <tbody> <tr> <td>Count</td> <td>1000 mega-pulse f.s.</td> <td>1 pulse</td> <td>0 to 1000 M pulse</td> </tr> <tr> <td rowspan="2">Rotational speed</td> <td>5000/n (r/s) f.s.</td> <td>1/n (r/s)</td> <td>0 to 5000/n (r/s)</td> </tr> <tr> <td>300,000/n (r/min) f.s.</td> <td>1/n (r/min)</td> <td>0 to 300,000/n (r/min)</td> </tr> </tbody> </table>	Measurement target	Range	Maximum resolution	Measurable range	Count	1000 mega-pulse f.s.	1 pulse	0 to 1000 M pulse	Rotational speed	5000/n (r/s) f.s.	1/n (r/s)	0 to 5000/n (r/s)	300,000/n (r/min) f.s.	1/n (r/min)	0 to 300,000/n (r/min)
Measurement target	Range	Maximum resolution	Measurable range													
Count	1000 mega-pulse f.s.	1 pulse	0 to 1000 M pulse													
Rotational speed	5000/n (r/s) f.s.	1/n (r/s)	0 to 5000/n (r/s)													
	300,000/n (r/min) f.s.	1/n (r/min)	0 to 300,000/n (r/min)													
	n: number of pulses per rotation (1 to 1000)															
Pulse input period	With filter off: 200 μs or greater (100 μs or greater during high and low interval) With filter on: 100 ms or greater (50 ms or greater during high and low interval)															
Slope	Set rising/falling for each channel.															
Measurement mode	Integration (addition, instantaneous), rotational speed															
Integration	Addition: counts number of pulses input from start of measurement. Instantaneous: counts number of pulses input within each recording interval (integrated value is reset for each rotational interval).															
Rotational speed	r/s: counts number of input pulses during 1 s and calculates rotational speed. r/min: counts number of input pulses during 1 min and calculates rotational speed.															
Smoothing function	Select value from 1 s to 60 s (valid only when set to rotational speed and r/min).															

Chatter prevention filter	Set to on/off for each channel
Logic input	
Measurement mode	Records 1 or 0 for each recording interval

## Software Logger Utility specifications

U8555 CAN unit and LR8535 wireless CAN unit are not supported.

Operating Environment	Windows7 (32/64 bit) Windows8 (32/64 bit) Windows10 (32/64 bit)
Overview	Control PC-connected logger to receive, display, and save measured waveform data sequentially. (Total recording samples is maximum 10 million data. Data exceeding this number will be segmented into separate measurement files while recording continues.) *Real-time measurement on the LR8450, LR8450-01 is possible with a recording interval of 10 ms or more.
Function	Controllable loggers: 5 Data Collection System: 1 system Display Format: • Waveforms (split time-axis display is possible) • Numerical values (logging): numerical display can be enlarged • Alarms Above items can be displayed simultaneously Numerical value monitor Display: display in a separate window is possible. Scroll: waveforms can be scrolled during measurement.
Data Collection	Settings: data collection settings of logger modules can be configured Monitor function can be checked before measurement. Save: save settings from multiple devices supporting real-time measurement (LUS format) and measurement data (LUW format) as one file. Data save format: real-time data collection file (LUW format), transfer data in real-time or non-real-time to Microsoft Excel®, Excel® template can be specified Event mark: recording during measurement is possible
Waveform Display	Supported files: waveform data file (LUW format, MEM format) Display format: waveforms (split time-axis display available), simultaneous display of numerical values (logging) is available Maximum number of channels: 2,035 channels (measured) + 60 channels (waveform calculation) Waveform display sheets: waveform of each channel can be displayed on any of the ten sheets Scroll: available Event mark recording: available Cursors: cursors A and B can be used to display voltage values at cursor positions. Screen capture: screen capture of waveform display is available
Data Conversion	Applicable files: waveform data file (LUW format, MEM format) Conversion section: all data, specified section Conversion format: CSV format (comma delimited, space delimited, tab delimited), transfer to Excel® sheet, LR5000 format (hrp2.hrp) Data thinning: simple thinning with any thinning number
Waveform Calculation	Calculation items: arithmetic operations Number of calculation channel: 60 channels
Numerical Calculations	Applicable data: waveform data file (LUW format, MEM format), real-time measurement data, waveform calculation Calculation items: average value, peak value, maximum value, time to maximum value, minimum value, time to minimum value, on time, off time, on count, off count, standard deviation, aggregation, area value, and integration Save calculation: performs numerical calculation and save to file
Search	Applicable data: real-time data collection file (LUW format), main unit measurement file (MEM format), waveform calculation data Search mode: event mark, date and time, maximum position, minimum position, local maximum position, local minimum position, alarm position, level, window, and variation
Print	Applicable printer: printer compatible to the OS in use Applicable data: waveform data file (LUW format, MEM format) Print format: waveform image, report print, list print (channel settings, event, cursor value) Print area: all area, specified area by A-B cursor Print preview: available

## Option specifications (sold separately)

Plug-in units: U8550, U8551, U8552, U8553, U8554, U8555

### Shared specifications

Host model	LR8450/LR8450-01 MEMORY HILOGGER
Operating temperature and humidity range	-10°C to 50°C, 80% RH or less (non-condensing)
Storage temperature and humidity range	-20°C to 60°C, 80% RH or less (non-condensing)
Vibration resistance	JIS D 1601:1995 5.3 (1), Class 1A (passenger vehicle) equivalent
Accessories	User manual, mounting screw × 2, wiring confirmation label (U8554 only)

Wireless units: LR8530, LR8531, LR8532, LR8533, LR8534, LR8535

### Shared specifications

Host model	LR8450-01 MEMORY HILOGGER
Control communications method	Connect wirelessly via Z3230 WIRELESS LAN ADAPTER (included)
Communications buffer memory	4 Mword (volatile memory) Saves data in the event of a communications error. Data is reset when communications are restored.
Operating temperature and humidity range	-20°C to 55°C, 80% RH (non-condensing) (charging temperature range: 5°C to 35°C)
Storage temperature and humidity range	-20°C to 60°C, 80% RH (non-condensing)
Vibration resistance	JIS D 1601:1995 5.3 (1), Class 1A (passenger vehicle) equivalent
LED display	Wireless connection and measurement status, error status, AC adapter or external power, battery power, charge status

Auto-connect function	Available
Accessories	Z3230 WIRELESS LAN ADAPTER, user manual, Z1008 AC ADAPTER, mounting plate, M3×4 screw × 2 (for use with mounting plate), wiring confirmation label (LR8534 only)
Z3230 wireless specifications	Wireless LAN (IEEE 802.11b/g/n) Range: 30 m (line of sight) Encryption: WPA-PSK/WPA2-PSK, TKIP/AES Channels: channel 1 to 11

### Power supply specifications

AC adapter	Z1008 AC ADAPTER (12 V DC, standard accessory) Rated supply voltage: 100 to 240 V AC Rated power supply frequency: 50/60 Hz Maximum rated power: 25 VA (including AC adapter) Normal power consumption (instrument only, without battery pack) LR8530, LR8532, LR8533: 2.5 VA LR8531: 3.0 VA LR8534, LR8535: 4.0 VA
Battery	Z1007 BATTERY PACK (when using AC adapter, AC adapter takes precedence.) Rated supply voltage: 7.2 V DC (Li-ion 2170 mAh) Maximum rated power LR8530, LR8532: 1.5 VA LR8531, LR8533: 2.0 VA LR8534, LR8535: 3.5 VA
External power supply	Rated supply voltage: 10 to 30 V DC Maximum rated power: 8 VA (30 V DC external power supply, while charging battery) Normal power consumption (12 V DC external power supply, without battery pack) LR8530, LR8532, LR8533: 2.5 VA LR8531: 3.0 VA LR8534, LR8535: 4.0 VA
Continuous operating time	When using Z1007 BATTERY PACK (all data refresh rates, good communications state, 23°C reference values) LR8530, LR8532, LR8533: approx. 9 h LR8531: approx. 7 h LR8534: approx. 5 h LR8535: approx. 10 h (approx. 5 h when using two non-contact CAN sensors)
Charging function	When Z1007 BATTERY PACK installed while connected to AC adapter or 10 to 30 V DC external power supply Charging time: approx. 7 h (23°C reference value)

**VOLTAGE/TEMP UNIT U8550**  
**UNIVERSAL UNIT U8551**  
**VOLTAGE/TEMP UNIT U8552**

**WIRELESS VOLTAGE/TEMP UNIT LR8530**  
**WIRELESS UNIVERSAL UNIT LR8531**  
**WIRELESS VOLTAGE/TEMP UNIT LR8532**

(Accuracy guaranteed for 1 year, post-adjustment accuracy guaranteed for 1 year)

### General specifications

Number of input channels	U8550: 15 (set voltage, thermocouple, or humidity for each channel) LR8530: 15 (set voltage or thermocouple for each channel) U8551, LR8531: 15 (set voltage, thermocouple, humidity, RTD, or resistor for each channel) U8552: 30 (set voltage, thermocouple, or humidity for each channel) LR8532: 30 (set voltage or thermocouple for each channel)
Input terminals	U8550, LR8530: M3 screw-type terminal block (2 terminals per channel) U8551, LR8531: push-button type terminal block (4 terminals per channel) U8552, LR8532: push-button type terminal block (2 terminals per channel)
Output terminals	M3 screw-type terminal block (1 output, 2 terminals, Z2000 HUMIDITY SENSOR power supply [can power up to 15 Z2000 HUMIDITY SENSOR])(LR8531 only)
Measurement target	U8550, U8552: voltage, temperature (thermocouples), humidity LR8530, LR8532: voltage, temperature (thermocouples) U8551, LR8531: voltage, temperature (thermocouples), humidity, temperature (RTD), resistor
Input type	Scanning by semiconductor relays All channels isolated (not isolated when measuring with RTD, resistance or humidity)
A/D resolution	16 bits
Maximum input voltage	±100 V DC (maximum voltage between input terminals without causing damage)
Maximum channel-to-channel voltage	300 V DC (maximum voltage that can be applied between each input channel without causing damage; not isolated when measuring with RTD, resistance or humidity) *Channels are isolated from each other with semiconductor relays. Never allow a voltage exceeding the product specifications, for example a lightning surge, to be applied across channels as doing so may cause the semiconductor relays to short.
Maximum rated terminal-to-ground voltage	300 V AC, DC (maximum voltage that can be applied between input channels and the instrument or its chassis, or between units without causing damage; humidity measurement not isolated)
Input resistance	10 MΩ or greater (10 mV f.s. to 2 V f.s. voltage ranges, thermocouple ranges, RTD and resistor ranges) 1 MΩ ±5% (10 V f.s. to 100 V f.s. voltage range, 1-5 V f.s. voltage range, humidity measurement)
Allowable signal source resistance	1 kΩ or less
Data refresh interval	10 ms to 10 s (10 selectable levels)
Digital filters	Digital filter cutoff frequency is automatically set to data refresh interval, burnout setting, and power supply frequency filter setting
Dimensions	U8550, U8551, U8552: approx. 134W × 70H × 63D mm (5.28"W × 2.76"H × 2.48"D) LR8530, LR8531, LR8532: approx. 154W × 106H × 57D mm (6.06"W × 4.17"H × 2.24"D)
Mass	U8550: approx. 345 g (12.2 oz.), U8551: approx. 318 g (11.2 oz.), U8552: approx. 319 g (11.3 oz.), LR8530: approx. 423 g (14.9 oz.), LR8531: approx. 386 g (13.6 oz.), LR8532: approx. 388 g (13.7 oz.), (including Z3230 WIRELESS LAN ADAPTER)
Accessories	Instruction Manual, installation screws × 2

### Analog input specifications

(23 ±5°C [73 ±9°F], 80% rh or less, after 30 minutes of warm-up and zero-adjustment, with the 50/60 Hz cut-off setting selected)

### Voltage

Range	Maximum resolution	Measurable range	Measurement accuracy
10 mV f.s.	500 nV	-10 mV to 10 mV	±10 μV
20 mV f.s.	1 μV	-20 mV to 20 mV	±20 μV
100 mV f.s.	5 μV	-100 mV to 100 mV	±50 μV
200 mV f.s.	10 μV	-200 mV to 200 mV	±100 μV
1 V f.s.	50 μV	-1 V to 1 V	±500 μV
2 V f.s.	100 μV	-2 V to 2 V	±1 mV
10 V f.s.	500 μV	-10 V to 10 V	±5 mV
20 V f.s.	1 mV	-20 V to 20 V	±10 mV
100 V f.s.	5 mV	-100 V to 100 V	±50 mV
1-5 V f.s.	500 μV	1 V to 5 V	±5 mV

### Temperature

Thermocouple (not including accuracy of reference junction compensation)  
Standards: JIS C1602-2015, IEC584

Type	Range	Measurable range	Maximum resolution	Measurement accuracy
K	100°C f.s.	0.01°C	-100°C to less than 0°C	±0.7°C
			0°C to 100°C	±0.5°C
			-200°C to less than -100°C	±1.4°C
				-100°C to less than 0°C
			0°C to 500°C	±0.5°C
				±1.4°C
	500°C f.s.	0.05°C	-200°C to less than -100°C	±1.4°C
			-100°C to less than 0°C	±0.7°C
			0°C to 500°C	±0.5°C
			-200°C to less than -100°C	±1.4°C
			-100°C to less than 0°C	±0.7°C
			0°C to less than 500°C	±0.5°C
J	100°C f.s.	0.01°C	-100°C to less than 0°C	±0.7°C
			0°C to 100°C	±0.5°C
			-200°C to less than -100°C	±0.9°C
				-100°C to less than 0°C
			0°C to 500°C	±0.5°C
				±0.9°C
	500°C f.s.	0.05°C	-200°C to less than -100°C	±0.9°C
			-100°C to less than 0°C	±0.7°C
			0°C to 500°C	±0.5°C
			-200°C to less than -100°C	±0.9°C
			-100°C to less than 0°C	±0.7°C
			0°C to 1,200°C	±0.5°C
E	100°C f.s.	0.01°C	-100°C to less than 0°C	±0.7°C
			0°C to 100°C	±0.5°C
			-200°C to less than -100°C	±0.9°C
				-100°C to less than 0°C
			0°C to 500°C	±0.5°C
				±0.9°C
	500°C f.s.	0.05°C	-200°C to less than -100°C	±0.9°C
			-100°C to less than 0°C	±0.7°C
			0°C to 1,000°C	±0.5°C
			-200°C to less than -100°C	±0.9°C
			-100°C to less than 0°C	±0.7°C
			0°C to 400°C	±0.5°C
T	100°C f.s.	0.01°C	-100°C to less than 0°C	±0.7°C
			0°C to 100°C	±0.5°C
			-200°C to less than -100°C	±1.4°C
				-100°C to less than 0°C
			0°C to 400°C	±0.5°C
				±1.4°C
	500°C f.s.	0.05°C	-200°C to less than -100°C	±1.4°C
			-100°C to less than 0°C	±0.7°C
			0°C to 400°C	±0.5°C
			-200°C to less than -100°C	±1.4°C
			-100°C to less than 0°C	±0.7°C
			0°C to 400°C	±0.5°C
N	100°C f.s.	0.01°C	-100°C to less than 0°C	±1.1°C
			0°C to 100°C	±0.9°C
			-200°C to less than -100°C	±2.1°C
				-100°C to less than 0°C
			0°C to 500°C	±0.9°C
				±2.1°C
	500°C f.s.	0.05°C	-200°C to less than -100°C	±2.1°C
			-100°C to less than 0°C	±1.1°C
			0°C to 1,300°C	±0.9°C
			-200°C to less than -100°C	±2.1°C
			-100°C to less than 0°C	±1.1°C
			0°C to 1,700°C	±2.2°C
R	100°C f.s.	0.01°C	0°C to 100°C	±4.4°C
			0°C to less than 100°C	±4.4°C
			100°C to less than 300°C	±2.9°C
			300°C to 500°C	±2.2°C
			0°C to less than 100°C	±4.4°C
			100°C to less than 300°C	±2.9°C
	500°C f.s.	0.05°C	0°C to less than 100°C	±4.4°C
			100°C to less than 300°C	±2.9°C
			300°C to 1,700°C	±2.2°C
			0°C to less than 100°C	±4.4°C
			100°C to less than 300°C	±2.9°C
			300°C to 500°C	±2.2°C
S	100°C f.s.	0.01°C	0°C to 100°C	±4.4°C
			0°C to less than 100°C	±4.4°C
			100°C to less than 300°C	±2.9°C
			300°C to 500°C	±2.2°C
			0°C to less than 100°C	±4.4°C
			100°C to less than 300°C	±2.9°C
	500°C f.s.	0.05°C	0°C to less than 100°C	±4.4°C
			100°C to less than 300°C	±2.9°C
			300°C to 1,700°C	±2.2°C
			0°C to less than 100°C	±4.4°C
			100°C to less than 300°C	±2.9°C
			300°C to 1,700°C	±2.2°C
B	2,000°C f.s.	0.1°C	400°C to less than 600°C	±5.4°C
			600°C to less than 1,000°C	±3.7°C
			1,000°C to 1,800°C	±2.4°C
			400°C to less than 600°C	±5.4°C
			600°C to less than 1,000°C	±3.7°C
			1,000°C to 1,800°C	±2.4°C
	100°C f.s.	0.01°C	0°C to 100°C	±1.7°C
			0°C to 500°C	±1.7°C
			0°C to 2,000°C	±1.7°C
			0°C to 100°C	±1.7°C
			0°C to 500°C	±1.7°C
			0°C to 2,000°C	±1.7°C



Other specifications about thermocouple measurement

Reference junction compensation: internal/external	At INT RJC, total accuracy = add $\pm 0.5^\circ\text{C}$
Thermocouple burnout detection: on/off	System will check for burnout at each data refresh interval during thermocouple measurement. (not available with 10 ms interval)

**U8550, U8551, U8552, LR8531 only input specifications**  
**Humidity** (use HUMIDITY SENSOR Z2000)

**HUMIDITY SENSOR Z2000**

Operating temperature and humidity range:  
 $0^\circ\text{C}$  to  $50^\circ\text{C}$  ( $32^\circ\text{F}$  to  $122^\circ\text{F}$ ), 100% RH or less (non-condensing)

Range	Maximum resolution	Measurable range
100% rh f.s.	0.1% rh	5.0% rh to 95.0% rh

**HUMIDITY SENSOR Z2000 accuracy**

If the humidity value lies on a boundary line below, the better of the two regions' measurement accuracy values applies.

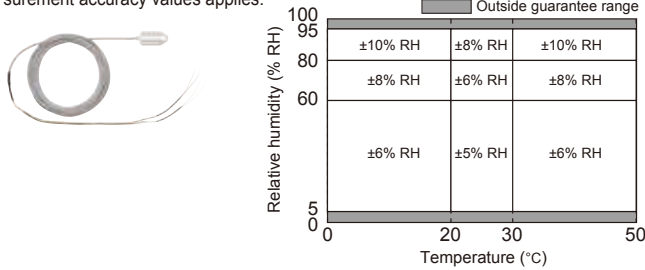

**U8551, LR8531 only input specifications**

**Temperature** Connection: 3-wire/4-wire, measurement current: 1 mA (Pt100, Jpt100), RTD 0.1 mA (Pt1000)  
 Standards: Pt100, Pt1000: JIS C1604-2013, IEC751 JPt100: JIS C1604-1989

Type	Range	Maximum resolution	Measurable range	Measurement accuracy
Pt100	100°C f.s.	0.01°C	-100°C to 100°C	$\pm 0.5^\circ\text{C}$
	500°C f.s.	0.05°C	-200°C to 500°C	$\pm 0.7^\circ\text{C}$
	2,000°C f.s.	0.1°C	-200°C to 800°C	$\pm 0.9^\circ\text{C}$
JPt100	100°C f.s.	0.01°C	-100°C to 100°C	$\pm 0.5^\circ\text{C}$
	500°C f.s.	0.05°C	-200°C to 500°C	$\pm 0.7^\circ\text{C}$
	2,000°C f.s.	0.1°C	-200°C to 500°C	$\pm 0.9^\circ\text{C}$
Pt1000	100°C f.s.	0.01°C	-100°C to 100°C	$\pm 0.5^\circ\text{C}$
	500°C f.s.	0.05°C	-200°C to 500°C	$\pm 0.7^\circ\text{C}$
	2,000°C f.s.	0.1°C	-200°C to 800°C	$\pm 0.9^\circ\text{C}$

\*When using Pt1000, data refresh intervals of 10ms, 20m, and 50ms are not available.

**Resistance**

Connection: 4-wire; measurement current is 1 mA

Range	Maximum resolution	Measurable range	Measurement accuracy
10 $\Omega$ f.s.	0.5 m $\Omega$	0 $\Omega$ to 10 $\Omega$	$\pm 10$ m $\Omega$
20 $\Omega$ f.s.	1 m $\Omega$	0 $\Omega$ to 20 $\Omega$	$\pm 20$ m $\Omega$
100 $\Omega$ f.s.	5 m $\Omega$	0 $\Omega$ to 100 $\Omega$	$\pm 100$ m $\Omega$
200 $\Omega$ f.s.	10 m $\Omega$	0 $\Omega$ to 200 $\Omega$	$\pm 200$ m $\Omega$

**HIGH SPEED VOLTAGE UNIT U8553** | **WIRELESS HIGH SPEED VOLTAGE UNIT LR8531**

(Accuracy guaranteed for 1 year, post-adjustment accuracy guaranteed for 1 year)

**General specifications**

Number of input channels	5 (voltage only)
Input terminals	M3 screw-type terminal block (2 terminals per channel), outfitted with terminal block cover
Measurement target	Voltage
Input type	Scanning by semiconductor relays, all channels isolated
A/D resolution	16 bits
Maximum input voltage	$\pm 100$ V DC (maximum voltage between input terminals without causing damage)
Maximum channel-to-channel voltage	300 V DC (maximum voltage between input channels without causing damage) *Channels are isolated from each other with semiconductor relays. Never allow a voltage exceeding the product specifications, for example a lightning surge, to be applied across channels as doing so may cause the semiconductor relays to short.
Maximum rated terminal-to-ground voltage	300 V AC, DC (maximum voltage between input channel and chassis, or between modules, without causing damage)
Input resistance	1 M $\Omega$ $\pm 5\%$
Allowable signal source resistance	100 $\Omega$ or less
Data refresh interval	1 ms to 10 s (13 selectable levels)
Digital filters	Digital filter cutoff frequency is automatically set to data refresh interval, burnout detection setting, and power supply frequency filter setting.
Dimensions	U8553: approx. 134W x 70H x 63D mm (5.28"W x 2.76"H x 2.48"D) LR8531: approx. 154W x 106H x 57D mm (6.06"W x 4.17"H x 2.24"D)
Mass	U8553: approx. 237 g (8.4 oz.) LR8531: approx. 370 g (13.1 oz.) (including Z3230 WIRELESS LAN ADAPTER)

**Analog input specifications**

( $23 \pm 5^\circ\text{C}$  /  $73 \pm 9^\circ\text{F}$ , 80% rh or less, after 30 minutes of warm-up and zero-adjustment, with the 50/60 Hz cut-off setting selected)

Measurement target	Range	Maximum resolution	Measurable range	Measurement accuracy
Voltage	100 mV f.s.	5 $\mu\text{V}$	-100 mV to 100 mV	$\pm 100$ $\mu\text{V}$
	200 mV f.s.	10 $\mu\text{V}$	-200 mV to 200 mV	$\pm 200$ $\mu\text{V}$
	1 V f.s.	50 $\mu\text{V}$	-1 V to 1 V	$\pm 1$ mV
	2 V f.s.	100 $\mu\text{V}$	-2 V to 2 V	$\pm 2$ mV
	10 V f.s.	500 $\mu\text{V}$	-10 V to 10 V	$\pm 10$ mV
	20 V f.s.	1 mV	-20 V to 20 V	$\pm 20$ mV
	100 V f.s.	5 mV	-100 V to 100 V	$\pm 100$ mV
1-5 V f.s.	500 $\mu\text{V}$	1 V to 5 V	$\pm 10$ mV	

**STRAIN UNIT U8554** | **WIRELESS STRAIN UNIT LR8534**

(Accuracy guaranteed for 1 year, post-adjustment accuracy guaranteed for 1 year)

**General specifications**

Number of input channels	5 (set voltage or strain for each channel)	
Input terminals	Push-button type terminal block (5 terminals per channel), outfitted with terminal block cover, set DIP switches according to measurement target	
Measurement target	Voltage	
	Strain	Strain gage-type converter Strain gage 1-gage method (2-wire setup), 1-gage method (3-wire setup), 2-gage method (adjacent sides), 4-gage method
Adaptive gage resistance	1-gage method, 2-gage method: 120 $\Omega$ (external bridge box required for 350 $\Omega$ ) 4-gage method: 120 $\Omega$ to 1 k $\Omega$	
Gage ratio	2.0 (fixed)	
Bridge voltage	2 V $\pm 0.05$ V DC	
Balance adjustment	Method	Electronic auto-balancing
	Range	Voltage: $\pm 20$ mV or less (1 mV f.s. to 20 mV f.s. range), $\pm 200$ mV or less (50 mV f.s. to 200 mV f.s. range) Strain: $\pm 20,000$ $\mu\epsilon$ or less (1,000 $\mu\epsilon$ f.s. to 20,000 $\mu\epsilon$ f.s. range), $\pm 200,000$ $\mu\epsilon$ or less (50,000 $\mu\epsilon$ f.s. to 200,000 $\mu\epsilon$ f.s. range)
Input type	Balanced differential input, simultaneous sampling of all channels (non-isolated channels)	
A/D resolution	16bit	
Maximum input voltage	$\pm 0.5$ V DC (maximum voltage between input terminals without causing damage)	
Maximum channel-to-channel voltage	Non-isolated (all channels share common GND)	
Maximum rated terminal-to-ground voltage	30 Vrms AC or 60 V DC (maximum voltage between input channel and chassis without causing damage)	
Input resistance	2 M $\Omega$ $\pm 5\%$	
Data refresh interval	1 ms to 10 s (13 selectable levels)	
Low-pass filter	Cut-off frequency: $-3$ dB $\pm 30\%$ Auto, 120, 60, 30, 15, 8, 4 (Hz) Auto: cut-off frequency of low-pass filter is automatically set based on set data refresh interval.	
	Attenuation characteristics: 5th-order butterworth filter, $-30$ dB/oct	
Dimensions	U8554: approx. 134W x 70H x 63D mm (5.28"W x 2.76"H x 2.48"D) LR8534: approx. 154W x 106H x 57D mm (6.06"W x 4.17"H x 2.24"D)	
Mass	U8554: approx. 236 g (8.3 oz.) LR8534: approx. 372 g (13.1 oz.) (including Z3230 WIRELESS LAN ADAPTER)	

**Analog input specifications**

( $23 \pm 5^\circ\text{C}$  /  $73 \pm 9^\circ\text{F}$ , 80% rh or less, auto-balance at least 30 minutes after power on, with LPF set at 4 Hz)

Measurement target	Range	Maximum resolution	Measurable range	Measurement accuracy
Voltage	1 mV f.s.	50 nV	-1 mV to 1 mV	$\pm 9$ $\mu\text{V}$
	2 mV f.s.	100 nV	-2 mV to 2 mV	$\pm 10$ $\mu\text{V}$
	5 mV f.s.	250 nV	-5 mV to 5 mV	$\pm 25$ $\mu\text{V}$
	10 mV f.s.	500 nV	-10 mV to 10 mV	$\pm 50$ $\mu\text{V}$
	20 mV f.s.	1 $\mu\text{V}$	-20 mV to 20 mV	$\pm 100$ $\mu\text{V}$
	50 mV f.s.	2.5 $\mu\text{V}$	-50 mV to 50 mV	$\pm 250$ $\mu\text{V}$
	100 mV f.s.	5 $\mu\text{V}$	-100 mV to 100 mV	$\pm 500$ $\mu\text{V}$
	200 mV f.s.	10 $\mu\text{V}$	-200 mV to 200 mV	$\pm 1$ mV
Strain	1,000 $\mu\epsilon$ f.s.	0.05 $\mu\epsilon$	-1,000 $\mu\epsilon$ to 1,000 $\mu\epsilon$	$\pm 9$ $\mu\epsilon$
	2,000 $\mu\epsilon$ f.s.	0.1 $\mu\epsilon$	-2,000 $\mu\epsilon$ to 2,000 $\mu\epsilon$	$\pm 10$ $\mu\epsilon$
	5,000 $\mu\epsilon$ f.s.	0.25 $\mu\epsilon$	-5,000 $\mu\epsilon$ to 5,000 $\mu\epsilon$	$\pm 25$ $\mu\epsilon$
	10,000 $\mu\epsilon$ f.s.	0.5 $\mu\epsilon$	-10,000 $\mu\epsilon$ to 10,000 $\mu\epsilon$	$\pm 50$ $\mu\epsilon$
	20,000 $\mu\epsilon$ f.s.	1 $\mu\epsilon$	-20,000 $\mu\epsilon$ to 20,000 $\mu\epsilon$	$\pm 100$ $\mu\epsilon$
	50,000 $\mu\epsilon$ f.s.	2.5 $\mu\epsilon$	-50,000 $\mu\epsilon$ to 50,000 $\mu\epsilon$	$\pm 250$ $\mu\epsilon$
	100,000 $\mu\epsilon$ f.s.	5 $\mu\epsilon$	-100,000 $\mu\epsilon$ to 100,000 $\mu\epsilon$	$\pm 500$ $\mu\epsilon$
	200,000 $\mu\epsilon$ f.s.	10 $\mu\epsilon$	-200,000 $\mu\epsilon$ to 200,000 $\mu\epsilon$	$\pm 1000$ $\mu\epsilon$

\* Internal bridge resistance precision tolerance:  $\pm 0.01\%$ ; temperature characteristics:  $\pm 2$  ppm/ $^\circ\text{C}$

\* Measurement accuracy does not include internal bridge resistance tolerance and temperature characteristics

<b>CAN UNIT U8555</b>	<b>WIRELESS CAN UNIT LR8535</b>
-----------------------	---------------------------------

**General specifications**

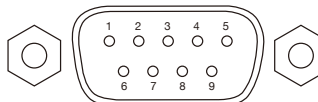
Number of ports	2																														
Input terminals	D-sub 9 pin MALE × 2																														
																															
	<table border="1" style="margin-left: auto; margin-right: auto;"> <thead> <tr> <th>Pin No.</th> <th>Signal</th> <th>Function</th> </tr> </thead> <tbody> <tr> <td>1</td> <td>N.C.</td> <td>Unused</td> </tr> <tr> <td>2</td> <td>CAN_L</td> <td>CAN_L communications line</td> </tr> <tr> <td>3</td> <td>GND</td> <td>GND</td> </tr> <tr> <td>4</td> <td>N.C.</td> <td>Unused</td> </tr> <tr> <td>5</td> <td>N.C.</td> <td>Unused</td> </tr> <tr> <td>6</td> <td>N.C.</td> <td>Unused</td> </tr> <tr> <td>7</td> <td>CAN_H</td> <td>CAN_H communications line</td> </tr> <tr> <td>8</td> <td>N.C.</td> <td>Unused</td> </tr> <tr> <td>9</td> <td>N.C.</td> <td>Unused</td> </tr> </tbody> </table>	Pin No.	Signal	Function	1	N.C.	Unused	2	CAN_L	CAN_L communications line	3	GND	GND	4	N.C.	Unused	5	N.C.	Unused	6	N.C.	Unused	7	CAN_H	CAN_H communications line	8	N.C.	Unused	9	N.C.	Unused
Pin No.	Signal	Function																													
1	N.C.	Unused																													
2	CAN_L	CAN_L communications line																													
3	GND	GND																													
4	N.C.	Unused																													
5	N.C.	Unused																													
6	N.C.	Unused																													
7	CAN_H	CAN_H communications line																													
8	N.C.	Unused																													
9	N.C.	Unused																													
Power supply terminals (LR8535 only)	USB port (connectors: Series A receptacle × 2) Dedicated power supply for Hioki NON-CONTACT CAN SENSOR																														
Interface	CAN, CAN FD, CAN FD (non-ISO)																														
Terminator	On/off setting available for each port 120 Ω ±10 Ω built-in resistance																														
ACT LED	Displays CAN bus operating status																														
TERM LED	Illuminates when terminator is on																														
Data refresh interval	10 ms to 10 s (10 selectable levels)																														
Baud rate	CAN/CAN FD (arbitration): 50k, 62.5k, 83.3k, 100k, 125k, 250k, 500k, 800k, 1,000k [Baud] CAN FD (data): 0.5M, 1M, 2M, 2.5M, 4M, 5M [Baud]																														
Sampling point	CAN or CAN FD (arbitration): 50.0% to 95.0% CAN FD (data): 50.0% to 95.0%																														
ACK transmission	ACK response when receiving CAN data can be set to on or off																														
Operation mode	U8555: supports switching between receive mode and measured value output mode LR8535: supports only receive mode																														
Dimensions	U8553: approx. 134W × 70H × 54D mm (5.28"W × 2.76"H × 2.13"D) LR8531: approx. 154W × 106H × 48D mm (6.06"W × 4.17"H × 1.89"D)																														
Mass	U8553: approx. 235g (8.3oz.) LR8531: approx. 355g (12.2oz.) (including Z3230 WIRELESS LAN ADAPTER)																														
<b>Receive mode specifications</b>																															
No. of measurement channels	Data refresh interval 10 ms: max. 50 channels (max. 50 signals) Data refresh interval 20 ms: max. 100 channels (max. 100 signals) Data refresh interval 50 ms: max. 250 channels (max. 250 signals) Data refresh interval 100 ms or greater: max. 500 channels (max. 500 signals)																														
Receive ID count	Function for recording the number of times a target ID is received during the data refresh interval																														
User-defined frame transmission (U8555 only)	Sends user-defined CAN frames during receive mode operation No. of configurable conditions: 8 per unit																														
<b>Measured values output mode specifications (U8555 only)</b>																															
Overview	Converts LR8450 measured values and output them as CAN frames.																														
Output target	Measurement data from plug-in modules (other than CAN Unit)																														
Output data refresh period	Depends on data refresh interval of module generating output (as fast as 1 ms)																														
Response	Data refresh interval × 2 + 1 ms + analog response time <sup>(*)</sup> <sup>(*)</sup> Varies with filter settings (U8554: 5 ms with 120 Hz low-pass filter)																														
<b>Function specifications (LR8535 only)</b>																															
LED display when in wireless mode	Wireless connection, measurement status, error status, AC adapter or external power supply, battery power, charge status																														
Control keys	[AUTO], [RESET]																														
Auto-connect function	Available																														

**CAN Editor (software) specifications**
**General specifications**

Operating environment	Windows 10 (32/64-bit), Windows 11 (64-bit)	
Interface	LAN/USB	
Supported languages	Japanese/English/Chinese	
Supported instruments	HIOKI LR8450/LR8450-01 MEMORY HILOGGER	
Set module position	Module 1 to module 4 Wireless module 1 to wireless module 7	
CAN interface setting	Interface, terminator, baud rate, data rate, sampling points, data sampling points, ACK	
Module operating mode	Switch between receive mode and measured value output mode on a module-by-module basis	
<b>Receive mode settings</b>		
Data refresh interval	10 ms to 10 s (10 selectable levels)	
Receive channel definition settings	CAN input port settings	Port 1 or Port 2
	Channel type	Data or ID count
	Shared settings	1. Format: standard/extended 2. ID: 0h to 1 FFFFFFFh 3. Comment 4. Unit 5. Factor, offset
	Channel type: data	1. Start bits: 0 to 511 2. Bit length: 1 to 64 [bits] 3. Byte order: Motorola/Intel 4. Data type: unsigned/signed/IEEE/float/IEEE-double
LR8450 display settings	1. Display upper limit value or display lower limit value 2. No. of display digits, display format 3. Numerical calculation threshold 4. Waveform color	
User-defined frame transmission settings	Receive condition number	No. 1 to No. 8
	CAN output port setting	Port 1 or Port 2
	No. of frame	1 to 8
	Regular transmission setting	On/off
	Regular transmission interval	1 to 9999 (× 10 [ms])
	Timing	At measurement start, at measurement stop, at start trigger, at alarm, manual
	Frame type	CAN standard, CAN extended, CAN FD standard, CAN FD extended
	Transmit ID	0 h to 1FFFFFF h
	DLC (bite)	0 to 15 (0, 12, 16, 20, 24, 32, 48, 64)
	Transmit data	Set as hexadecimal value
Delay	0 to 9999 (× 10 [ms])	
<b>Measured value output mode setting</b>		
Measured value output setting	CAN output port setting	Port 1 or Port 2
	Frame type	Standard/extended
	ID	0 h to 1FFFFFF h
Data	Measured values from the following modules can be set as output data U8550, U8551, U8552, U8553, U8554	
CAN bus load ratio estimation function	Displays what would be the CAN bus load increase rate if measured values were to be output using the current settings	
<b>File specifications</b>		
Save function	1. CANdb file (.dbc) for transmit data defined using measured value output mode settings 2. Overall settings data for CAN Editor (.CES)	
	Load function	1. Loads CANdb files (.dbc) and MR8904 definition files (.CDF) and use them to configure receive channel settings. 2. Loads LR8450 settings (.SET) and CAN Editor settings (.CES) and applies them to the CAN Editor's overall settings.
Title	Sets titles for settings data (.CES) (up to 50 single-byte or 25 double-byte characters).	

## Model: MEMORY HiLOGGER LR8450



Model No. (order code)	Specifications
LR8450	Standard model, main unit only
LR8450-01	Wireless LAN equipped model, main unit only

- The LR8450 and LR8450-01 cannot perform measurement on their own. One or more plug-in modules or wireless modules are required (sold separately).
- The LR8450-01 and each wireless module emit radio waves. Use of radio waves is subject to licensing requirements in certain countries. Using it in a country or region other than those indicated may violate the law and may result in legal penalties for the operator. For the latest information about countries and regions where wireless operation is currently supported, please visit the Hioki website.

## Option

### Plug-in modules



#### VOLTAGE/TEMP UNIT U8550

Channels: 15; maximum sampling rate: 10 ms



#### UNIVERSAL UNIT U8551

Channels: 15; maximum sampling rate: 10 ms



#### VOLTAGE/TEMP UNIT U8552

Channels: 30; maximum sampling rate: 20 ms  
(When 15 or fewer channels are used, 10 ms)



#### HIGH SPEED VOLTAGE UNIT U8553

Channels: 5; maximum sampling rate: 1 ms



#### STRAIN UNIT U8554

Channels: 5; maximum sampling rate: 1 ms



#### CAN UNIT U8555

Ports: 2, input: CAN or CAN FD, output: CAN or CAN FD  
maximum sampling rate: 10 ms

### Wireless modules



#### WIRELESS VOLTAGE/TEMP UNIT LR8530

Channels: 15; maximum sampling rate: 10 ms

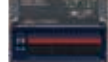

#### WIRELESS UNIVERSAL UNIT LR8531

Channels: 15; maximum sampling rate: 10 ms

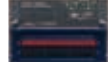

#### WIRELESS VOLTAGE/TEMP UNIT LR8532

Channels: 30; maximum sampling rate: 20 ms  
(When 15 or fewer channels are used, 10 ms)



#### WIRELESS HIGH SPEED VOLTAGE UNIT LR8533

Channels: 5; maximum sampling rate: 1 ms



#### WIRELESS STRAIN UNIT LR8534

Channels: 5; maximum sampling rate: 1 ms



#### WIRELESS CAN UNIT LR8535

Ports: 2, input: CAN or CAN FD, maximum sampling rate: 10 ms

### Power supplies

#### For instrument and wireless modules



#### BATTERY PACK Z1007

Instrument takes two; wireless modules take one

#### For instrument



#### AC ADAPTER Z1014

Ships standard with LR8450/LR8450-01

#### For wireless modules



#### AC ADAPTER Z1008

Ships standard with wireless modules

### Fixed Stand



#### FIXED STAND Z5040

For installing logger on wall

### CASE



#### CARRYING CASE C1012

Accommodates instrument and four plug-in modules or seven wireless modules

### Wireless Lan Adapter

#### For wireless modules



#### WIRELESS LAN ADAPTER Z3230

Ships standard with wireless modules

## Cables, sensors, etc.



#### LAN CABLE 9642

Straight Ethernet cable, supplied with straight to cross conversion adapter, 5 m (16.41 ft) length



#### HUMIDITY SENSOR Z2000

(analog output), 3 m (9.84 ft) length



#### Thermocouple

For reference only. Please purchase locally.



#### CAN CABLE 9713-01

For the U8555, LR8535. Unprocessed on one end, 1.8 m (5.91 ft) length



#### NON-CONTACT CAN SENSOR SP7001-95

Supports CAN FD or CAN signals, SP7001, SP9250, SP7150 set

### Storage media

\*Always use HIOKI optional storage media. Proper operation is not guaranteed when using storage media from other manufacturers, and may prevent the product from saving and loading data properly.



#### SD memory card Z4001

2 GB capacity



#### SD memory card Z4003

8 GB capacity



#### USB drive Z4006

16 GB, long-life, high-reliability SLC flash memory

### For the PC



#### LOGGER UTILITY/CAN EDITOR

LOGGER UTILITY: The control of the measurement of loggers, real-time data collection  
CAN EDITOR: CAN configuration software  
Standard accessory

You can download the latest version from our website.



#### GENNECT One

Displays measurement results from multiple instruments in graph form  
Free application for Windows

Note: Company names and product names appearing in this catalog are trademarks or registered trademarks of various companies.

# HIOKI

HIOKI E. E. CORPORATION

DISTRIBUTED BY

#### HEADQUARTERS

81 Koizumi,  
Ueda, Nagano 386-1192 Japan  
<https://www.hioki.com/>



Scan for all regional contact information